

COLPHARMA  [®]

Air 100

F A M I L Y

Sistema per aerosolterapia
ad aria compressa



12475

IT

EN

DE

FR





Fig. 1 / Pic. 1 / Abb. 1 / Fig. 1

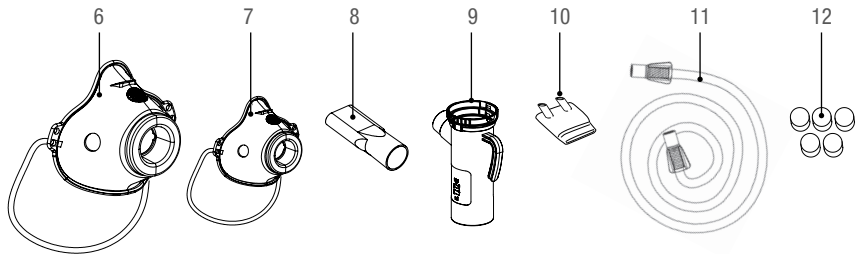
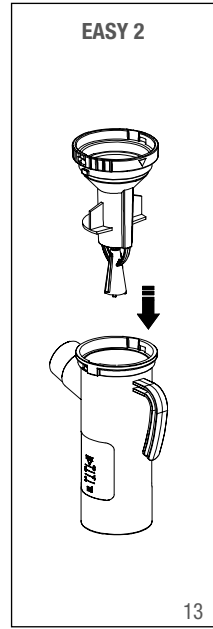
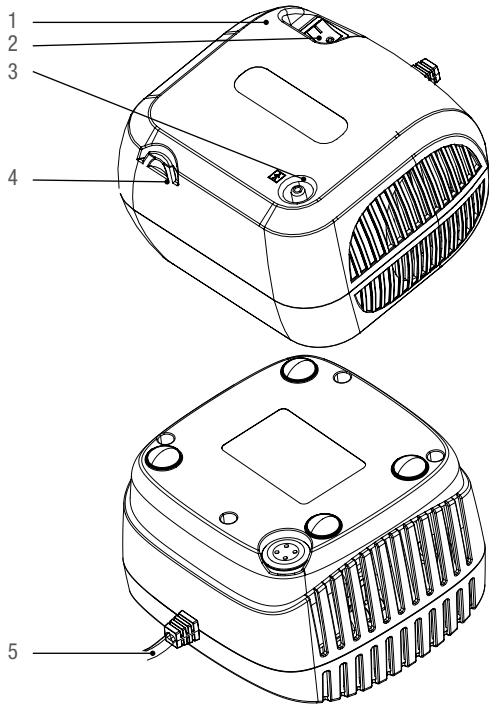

2



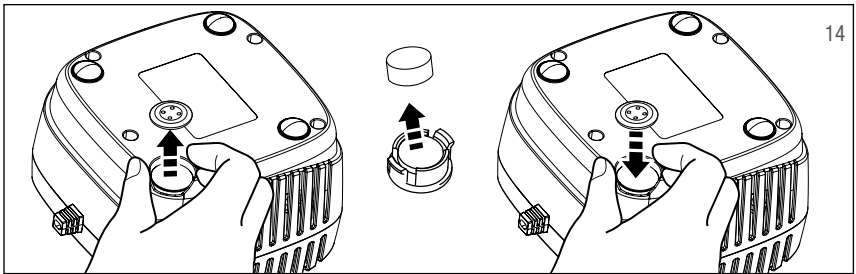
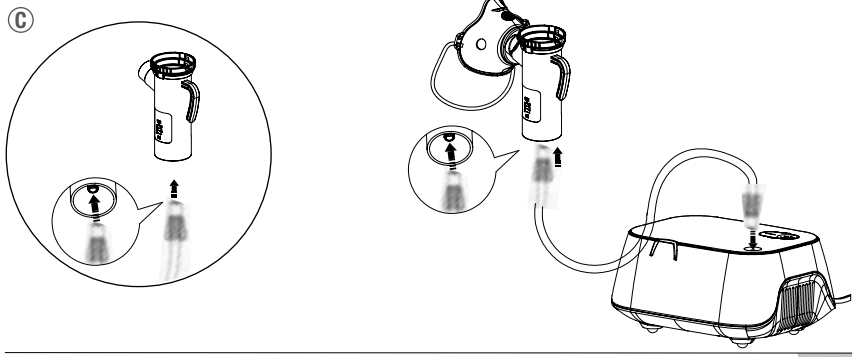
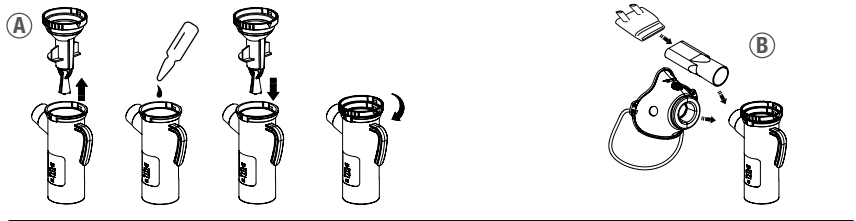

Fig. 2 / Pic.2 / Abb. 2 / Fig. 2

Istruzioni brevi / Short instructions / Kurze Anweisungen / Brèves instructions





Air 100

F A M I L Y

IT

Sistema per aerosolterapia ad aria compressa

- | | | | |
|---|-------------------------------|----|--|
| 1 | Compressore | 9 | Nebulizzatore EASY 2 |
| 2 | Pulsante ON/OFF | 10 | Erogatore nasale morbido |
| 3 | Presa tubo d'aria | 11 | Tubo aria |
| 4 | Supporto per il nebulizzatore | 12 | 5 Filtri aria |
| 5 | Cavo di alimentazione | 13 | Componenti e assemblaggio del nebulizzatore EASY 2 |
| 6 | Mascherina adulti | 14 | Sostituzione del filtro aria |
| 7 | Mascherina pediatrica | | |
| 8 | Boccaglio | | |



Leggere attentamente le istruzioni prima di usare questo dispositivo.



Parte applicata tipo BF.

Gentile cliente,
questo dispositivo è un sistema per aerosolterapia di alta qualità, ideale per uso occasionale domiciliare. È dotato del nebulizzatore EASY 2 studiato per il trattamento delle patologie respiratorie in modo rapido ed efficace.

Può essere utilizzato con tutti i comuni farmaci per aerosolterapia. In caso di domande, problemi o per ordinare parti di ricambio, contattare il proprio rivenditore di fiducia o il servizio clienti COLPHARMA. In alternativa è possibile visitare il sito www.colpharma.com che offre moltissime informazioni utili sui nostri prodotti.





DESTINAZIONE D'USO

Questo prodotto è destinato a essere utilizzato per l'inalazione di farmaci per la cura dei disturbi respiratori.

A chi è destinato il prodotto

- Personale medico legalmente abilitato (medici, infermieri e terapisti).
- Pazienti a casa con assistenza domiciliare per il trattamento sotto la guida di personale medico qualificato.



L'utilizzatore deve essere in grado di comprendere in linea generale il funzionamento del dispositivo e il contenuto del manuale di istruzioni.



Il dispositivo non deve essere utilizzato da pazienti che non sono coscienti o che non respirano autonomamente.

Pazienti ai quali è destinato il prodotto

Persone che soffrono di problemi respiratori e hanno la necessità di assumere farmaci per inalazione. Idoneo sia per uso pediatrico che per adulti.

Ambiente

Questo prodotto è destinato all'utilizzo domestico, in ambienti ambulatoriale e ospedaliero.

Durata minima prevista

I periodi di durata minima sono riportati di seguito e partono dal presupposto che il prodotto venga utilizzato per nebulizzare soluzione salina (2 ml) per 2 volte al giorno, 7,5 minuti per volta, a una temperatura ambiente di 23 °C.

Il periodo di durata può variare in base all'ambiente di utilizzo.

- Compressore (unità principale): 3 anni.
- Nebulizzatore - Tubo aria - Boccaglio - Erogatore nasale - Mascherina pediatrica - Mascherina adulti: 1 anno.
L'uso frequente del prodotto potrebbe accorciare la durata prevista.
- Filtro aria: 60 giorni.

Precauzioni d'uso

È necessario seguire le avvertenze e le precauzioni riportate nel manuale di istruzioni.





IMPORTANTI MISURE PRECAUZIONALI

- Seguire le istruzioni per l'uso. Questo manuale contiene informazioni importanti sul funzionamento e la sicurezza di questo dispositivo. Si prega di leggere attentamente le istruzioni per l'uso prima di utilizzare il dispositivo e di conservarle per ogni futura consultazione.
 - Questo dispositivo deve essere usato esclusivamente come descritto in questo manuale. Il produttore non può essere ritenuto responsabile di danni causati da un utilizzo improprio.
 - Il dispositivo non è adatto per anestesia e ventilazione polmonare.
 - Il dispositivo deve essere utilizzato solo con gli accessori originali indicati nel manuale d'uso.
 - Non usare il dispositivo se si ritiene che sia danneggiato o se si nota qualcosa di strano.
 - Non aprire mai il dispositivo.
 - Questo dispositivo è costruito con componenti delicati e deve essere trattato con attenzione. Osservare le condizioni di stoccaggio e funzionamento descritte nel capitolo «Specifiche tecniche».
 - Proteggere il dispositivo da:
 - acqua e umidità
 - temperature estreme
 - urti e cadute
 - contaminazione e polvere
 - luce solare diretta
 - caldo e freddo
 - Utilizzare il dispositivo solo con farmaci prescritti dal proprio medico e seguire le istruzioni di dosaggio, durata e frequenza della terapia prescritte.
 - Non inclinare il nebulizzatore oltre 45°.
 - Non usare il dispositivo vicino a forti campi elettromagnetici come telefoni cellulari o installazioni radio. Mantenere una distanza minima di 3,3 m da altri apparecchi quando si utilizza questo dispositivo.
 - Riporre il dispositivo e i suoi accessori in un posto pulito.
 - Non utilizzare e riporre questo dispositivo in presenza di fumi e gas.
 - Non utilizzare farmaci rimasti nel nebulizzatore ma utilizzarne sempre di nuovi.
 - Non utilizzare con circuiti per anestesia o ventilazione respiratoria.
-  Assicurarsi che i bambini non utilizzino il dispositivo senza la supervisione di un adulto. Alcune parti sono piccole e potrebbero essere ingerite. Prestare attenzione al rischio di strangolamento in presenza di cavi o tubi.



I dispositivi elettronici devono essere smaltiti in conformità alle regolamentazioni locali e non con i rifiuti domestici.



L'utilizzo di questo dispositivo non sostituisce la consultazione del proprio medico.





PREPARAZIONE E UTILIZZO DEL DISPOSITIVO

Quando si utilizza il dispositivo per la prima volta, si raccomanda di pulirlo come descritto nella sezione «Pulizia e disinfezione».

1. Aprire il nebulizzatore (9) e versare la quantità di farmaco prescritta dal proprio medico. Assicurarsi di non eccedere il livello massimo (Fig. 2/A).
2. Scegliere l'accessorio per inalazione più idoneo come prescritto dal proprio medico (Fig. 2/B).
3. Connettere il nebulizzatore con il tubo aria al compressore (Fig. 2/C) e inserire la spina del cavo di alimentazione nella presa di corrente assicurandosi che la rete sia conforme a quanto dichiarato in questo manuale o nei dati di targa del dispositivo.
4. Premere il pulsante ON/OFF (2) per accendere il dispositivo. Mettere in bocca il boccaglio (8), appoggiare l'erogatore nasale (10) sotto le narici o la mascherina (6 o 7) alla faccia facendo attenzione che copra bocca e naso.
5. Sedersi in posizione rilassata con la parte superiore del corpo dritta.

Non sdraiarsi durante l'inalazione.

6. Dopo aver completato la seduta inalatoria come raccomandato dal proprio medico, premere il pulsante ON/OFF (2) per spegnere il dispositivo e staccare la spina dalla rete di alimentazione.
7. Verificare che non vi sia condensa nel tubo dell'aria. In caso di condensa accendere il dispositivo per asciugare l'umidità presente nel tubo e successivamente scollegarlo come detto sopra.
8. Svuotare il farmaco rimanente nel nebulizzatore e pulire il dispositivo come descritto nella sezione «Pulizia e disinfezione».

 Questo dispositivo è stato progettato per un funzionamento 20 min. ON / 40 min. OFF.

 Non coprire il dispositivo con un panno, un asciugamano o altro durante l'utilizzo per evitare il surriscaldamento o il malfunzionamento dello stesso.





PULIZIA E DISINFEZIONE

Pulire attentamente tutti i componenti e rimuovere residui di farmaco e possibili impurità dopo ogni trattamento.

Il compressore (1) e il tubo aria (11) vanno puliti con un panno pulito e umido.

 Pulirsi sempre bene le mani prima di procedere alla pulizia e disinfezione degli accessori.

 Lavare/sterilizzare il nebulizzatore in ogni suo componente.

 Non esporre il compressore all'acqua o al calore.

 Sostituire il tubo aria quando si passa a un nuovo paziente o in caso di impurità.



Prima della pulizia, scollegare la spina dalla presa di corrente.



Il compressore non è impermeabile e non deve venire a contatto con liquidi. In caso di contatto con liquidi, staccare immediatamente la spina, spegnere il dispositivo e asciugarlo con cura. Non immergerlo nei liquidi.

Pulizia con acqua

- Pulire tutti i componenti (**eccetto il tubo aria**) sotto acqua corrente calda per circa 5 minuti aggiungendo, se necessario, una piccola quantità di detergente neutro seguendo il dosaggio e le limitazioni previste dal produttore del detergente.
- Sciacquare accuratamente facendo attenzione che tutti i residui siano rimossi e lasciare asciugare.

Disinfezione

- Tutti i componenti (**eccetto il tubo aria**) possono essere disinfettati con disinfettanti chimici utilizzando dosi e limitazioni previste dal produttore del disinfettante.
- I disinfettanti sono generalmente disponibili in farmacia.

Sterilizzazione a vapore

- Tutti i componenti (**eccetto il tubo aria e le mascherine**) possono essere sterilizzati a vapore fino a 100 °C (15-20 min.).
- Dopo la sterilizzazione lasciare sempre raffreddare i componenti fino a temperatura ambiente prima di un ulteriore uso.

 Non ripetere il ciclo di sterilizzazione quando i componenti sono ancora caldi.





Sterilizzazione con acqua bollente

- Tutti i componenti (**eccetto il tubo aria e le mascherine**) possono anche essere immersi in acqua bollente per non più di 1 minuto.

 Bollire i componenti in abbondante acqua.

 Smontare il nebulizzatore in tutti i suoi componenti e bollire separatamente.

MANUTENZIONE, CONSERVAZIONE E SERVIZIO

Ordinare tutti i pezzi di ricambio dal proprio rivenditore e farmacia di fiducia o contattare il servizio clienti COLPHARMA (vedere premessa).

- Si raccomanda di sostituire il nebulizzatore, il boccaglio, l'erogatore nasale e le mascherine dopo 1 anno di utilizzo.
- Non asciugare il nebulizzatore in forno o con l'asciugacapelli perché potrebbero deteriorarsi i suoi componenti.
- Verificare sempre che il filtro sia costantemente pulito e sostituirlo subito se sporco o dopo un massimo di 60 giorni di utilizzo. Filtri di ricambio vengono forniti con il dispositivo.
- Per sostituire il filtro (14), togliere il copri filtro dal suo alloggiamento. Rimuovere il filtro aria usato e inserire il nuovo filtro. Riposizionare il copri filtro nel suo alloggiamento.
- Non utilizzare il dispositivo senza filtro. Usare solo filtri originali.
- Non tentare di lavare il filtro. Se il filtro è bagnato sostituirlo. Il filtro umido può causare il blocco del dispositivo.
- Lavare regolarmente il copri filtro (non bollirlo) asciugandolo con cura prima di riposizionarlo nell'alloggiamento.

 Non aprire mai il vano compressore.

- Eventuali riparazioni possono essere effettuate solo da personale specializzato.





MALFUNZIONAMENTI E AZIONI DA INTRAPRENDERE

Il dispositivo non si accende

- Accertarsi che la spina sia ben inserita nella presa di corrente.
- Accertarsi di aver premuto il pulsante ON/OFF (2).
- Assicurarsi che il dispositivo operi entro i limiti indicati nel presente manuale d'istruzioni (20 min. ON / 40 min. OFF).

La nebulizzazione è debole o inesistente

- Assicurarsi che il tubo aria (11) sia connesso correttamente ai due estremi.
- Assicurarsi che il tubo aria non sia schiacciato, piegato, sporco o ostruito. Se necessario, sostituirlo con uno nuovo.
- Assicurarsi che il nebulizzatore sia completamente assemblato (13) e che i suoi componenti siano assemblati correttamente.
- Accertarsi che il farmaco sia stato versato nel nebulizzatore.
- Assicurarsi che il filtro sia pulito e che il copri filtro sia correttamente posizionato.

Il dispositivo è più rumoroso

- Assicurarsi di aver inserito correttamente il filtro nell'apposito alloggiamento (14).



Non provare a riparare il dispositivo, contattare il servizio clienti COLPHARMA.

GARANZIA

Questo dispositivo è coperto da una garanzia di **3 anni** dalla data di acquisto. La garanzia è valida solo presentando lo scontrino fiscale.

- La garanzia copre solo il compressore.
- Le parti di ricambio quali il nebulizzatore, le mascherine, il boccaglio, l'erogatore nasale, il tubo aria e i filtri sono garantiti 1 anno da difetti di fabbrica ma non dal deterioramento causato dalla normale usura.
- L'apertura o la manomissione del dispositivo invalidano la garanzia.
- La garanzia non copre danni causati da trattamento improprio, incidenti o inosservanza delle istruzioni per l'uso.





SPECIFICHE TECNICHE

Nebulizzatore:	EASY 2
Volume massimo di riempimento:	8 ml
Volume minimo di riempimento:	2 ml
Volume residuo:	0,5 ml
Velocità di nebulizzazione (NaCl 0,9%):	0,35 ml/min
Dimensione delle particelle:	4,07 μm - 61% < 5 μm
<hr/>	
Lunghezza tubo aria:	1,5 m
Pressione massima:	2,2 bar
Flusso al compressore:	12 L/min
Flusso operativo:	5 L/min
Livello sonoro (senza tubo):	55 dBA
Ciclo operativo:	20 min ON / 40 min OFF
Condizioni d'esercizio:	10-40 °C; 30-85% umidità relativa massima; 700-1060 hPa pressione atmosferica
Condizioni di spedizione e stoccaggio:	-10 - +40 °C; 10-95% umidità relativa massima; 700-1060 hPa pressione atmosferica
Peso prodotto:	1.300 g
Dimensioni:	140 x 137 x 92 mm
Alimentazione:	Spina a rete
Vita utile:	1.000 ore
Classe IP:	IP21
Standard di riferimento:	EN13544-1; EN60601-1; EN60601-2; EN60601-1-6; IEC60601-1-1-11

Con riserva di apportare modifiche tecniche.





Air 100

F A M I L Y

Compressed-air aerosol therapy

EN

- | | | | |
|---|------------------|----|---|
| 1 | Compressor | 9 | EASY 2 Nebulizer |
| 2 | ON/OFF button | 10 | Soft nose piece |
| 3 | Air tube outlet | 11 | Air tube |
| 4 | Nebulizer holder | 12 | 5 Air filters |
| 5 | Power cable | 13 | Components and assembly of EASY 2 nebulizer |
| 6 | Adult mask | 14 | Air filter replacement |
| 7 | Pediatric mask | | |
| 8 | Mouthpiece | | |



Read the instructions carefully before using this device



BF type part applied.

Dear Customer,

This device is a high-quality aerosol therapy system, ideal for home use.

It is provided with the EASY 2 nebulizer, which has been designed to treat respiratory illnesses quickly and effectively.

It can be used with the most common aerosol-therapy medicines. If you have any questions or concerns or if you need to order spare parts, please contact your dealer or the COLPHARMA customer care service. Alternatively, visit the www.colpharma.com website where you can find additional information on all our products.





INTENDED USE

This product has been designed for the inhalation of medicines for the treatment of respiratory illnesses.

Intended audience

- Certified medical professionals (physicians, nurses and therapists).
- Patients in their home environment with home health-care support for treatment under the directions of a qualified physician.



The user must understand the general operation of the device and the content of the instruction manual.



It is forbidden to use the device on patients who are unconscious or who cannot breath on their own.

Intended patients

People who suffer from respiratory illnesses and who need to take inhalation medicines.
Suitable both for pediatric and adult use.

Environment

This product has been designed for home use, as well as for medical clinic settings and hospital use.

Minimum product lifespan

The minimum product lifespan periods are reported below and are based on the assumption that the product is used to nebulize a saline solution (2 ml) twice a day, 7.5 minutes at a time, at an ambient temperature of 23 °C.

The lifespan period may vary depending on the usage environment.

- Compressor (main unit): 3 years.
- Nebulizer - air tube - mouthpiece - nose piece - pediatric mask – adult mask: 1 year.
Frequent product use may shorten the expected lifespan.
- Air filter: 60 days.



Warnings

Follow the warnings and precautions reported in the instruction manual.





IMPORTANT PRECAUTIONS

- Follow the instructions for use. This manual contains important information on the operation and safety of this device. Please, read the instructions carefully before using the device and keep them handy for future reference.
 - This device must be used exclusively as described in this manual. The manufacturer shall not be liable for any damages caused by improper use.
 - The device is not suitable for anesthesia and pulmonary ventilation.
 - The device must be used only with its original accessories as listed in the user manual.
 - Do not use the device if you deem it damaged or if you notice any anomaly.
 - Never open the device.
 - This device has been manufactured using sensitive components and it must be handled with care. Please, follow the storage and operation instructions detailed in the “Technical Specifications” chapter.
 - Make sure to safeguard the product from:
 - water and humidity
 - extreme temperature
 - impacts and falls
 - contamination and dust
 - direct sunlight
 - heat and cold
 - Use this device only with the medicines prescribed by the physician and follow dosing, duration and frequency instructions for the prescribed therapy.
 - Do not bend the nebulizer beyond 45°.
 - Do not use the device close to strong magnetic fields such as cellular phones and radio installations. Keep a minimum distance of 3.3 m from other equipment when using this device.
 - Store the device and its accessories in a clean place.
 - Do not use and store this device if smoke or gas is present.
 - Do not use any medicines left in the nebulizer. Always use a fresh new dose.
 - Do not use this product on anesthesia or pulmonary ventilation circuits.
-  Children must always use this device under adult supervision. Some parts are small and may represent a choking hazard if swallowed. Cables and tubes may represent a choking hazard.
-  Electronic devices must be disposed of according to local regulations and not as ordinary household waste.
-  The use of this device does not replace the medical advice of a physician.





HOW TO PREPARE AND USE THE DEVICE

When using the device for the first time, make sure to clean all parts as described in the section “Cleaning and Disinfection”.

1. Open the nebulizer (9) and pour in the amount of medicine as prescribed by the physician. Make sure not to pass the maximum level mark (Pic. 2/A).
2. Choose the most suitable inhalation accessory, as prescribed by the physician (Pic. 2/B).
3. Connect the nebulizer to the compressor using the air tube (Pic. 2/C) and plug in the power cord in an electric outlet making sure that the supply voltage is in compliance with what is stated in this manual or the device nameplate.
4. Press the ON/OFF (2) button to turn on the device. Place the mouthpiece in the mouth (8), let the nose piece rest (10) under the nostrils or the mask (6 or 7) on the face making sure to cover mouth and nose.
5. Sit in a relaxed position with the upper body straight.
Do not lie down while inhaling.
6. After having completed the therapy session as recommended by the physician, press the ON/OFF (2) button to turn off the device and unplug the power cord from the electric outlet.
7. Make sure that the air tube contains no condensation. In case of condensation, switch on the device to dry up any moisture in the tube and then disconnect it as described above.
8. Empty out the remaining medicine from the nebulizer and clean the device in all of its parts, as described in the section “Cleaning and Disinfection”.

 This device has been designed to work 20 min. ON / 40 min. OFF.

 Do not cover the device with a cloth, towel or anything else when in operation to avoid overheating or malfunction of the device.







CLEANING AND DISINFECTION

Carefully clean all parts and remove any medicine residues and possible impurities after each treatment. The compressor (1) and the air tube (11) must be wiped clean with a clean damp cloth.

 Always wash hands thoroughly before cleaning and disinfecting the accessories.

 Wash/sterilize every part of the nebulizer.

 Do not expose the compressor to water or heat.

 Replace the air tube when passing to a new patient or in case of impurities.



Before cleaning, disconnect the plug from the electric outlet.



The compressor is not waterproof and must not get in contact with liquids. In case of contact with liquids, immediately disconnect the power cord, shut off the device and dry it with care. Do not immerse the device in liquids.

Cleaning with water

- Clean all of the device's parts (**except for the air tube**) under hot running water for about 5 minutes, adding a small amount of neutral detergent if necessary, following the dosage and limits specified by the detergent manufacturer.
- Rinse thoroughly, taking care to remove all residues, then leave to dry.

Disinfection

- All parts (**except for the air tube**) can be disinfected with chemical disinfectants, using doses and limits as specified by the manufacturer of the disinfectant.
- Disinfectants are generally available from pharmacies.

Steam sterilization

- All of the components (**except for the air tube and the masks**) can be steam-sterilized up to a temperature of 100°C (15-20 min.).
- After sterilizing, always leave the components to cool down to ambient temperature before using again.

 Do not repeat the sterilization cycle when the components are still hot.





Sterilization in boiling water

- All of the components (**except for the air tube and the masks**) can be immersed in boiling water for no longer than 1 minute.



Boil the components in plenty of water.



Disassemble all components of the nebulizer and boil them separately.

MAINTENANCE, STORAGE AND SERVICING

Order all the spare parts from your retailer and trusted pharmacy or contact COLPHARMA customer service (see intro).

- It is recommended to replace the nebulizer, mouthpiece, nose piece and masks after 1 year of use.
- Do not dry the nebulizer in the oven or with a hairdryer or its components may be damaged.
- Always check that the filter is clean and replace it immediately if dirty or after a maximum of 60 days of use. Spare filters are provided with the device.
- To replace the filter (14), remove the filter cover from its seat.
Remove the used air filter and insert the new filter. Reposition the filter cover in its seat.
- Do not use the device without a filter installed. Use only original filters.
- Do not wash the filter. If the filter is wet, replace it. If the filter is damp it may cause the device to stop operating.
- Wash the filter cover regularly (do not boil it) then dry it carefully before repositioning it in its seat.



Never open the compressor compartment.

- Repairs must be performed exclusively by specialized personnel.





MALFUNCTIONS AND TROUBLESHOOTING

The device does not turn on

- Make sure that the plug is well inside the wall socket.
- Make sure to have pressed the ON/OFF (2) button.
- Make sure that the device is operating within the limits established in this instruction manual (20 min. ON / 40 min. OFF).

Nebulization is weak or not present

- Make sure that the air tube (11) is correctly connected at both ends.
- Make sure the air tube is not squashed, bent, soiled or blocked. If necessary, replace with a new one.
- Make sure the nebulizer is completely assembled (13) and ensure the components are correctly assembled.
- Make sure the medicine has been poured into the nebulizer.
- Make sure the filter is clean and the filter cover is positioned correctly.

The device is noisy

- Make sure to have inserted the filter correctly in its seat (14).



Do not attempt to repair the device. Contact COLPHARMA customer service.

WARRANTY

This device has a **3-year** warranty from the date of purchase. The warranty is valid only with the original purchase receipt.

- The 3-year warranty is valid only for the compressor.
- The spare parts such as nebulizer, masks, mouthpiece, nose piece, air tube and filters have a warranty of one year against defects in materials and workmanship, but not against deterioration caused by normal wear and tear.
- Opening or tampering with the device voids the warranty.
- The warranty does not cover damage caused by improper use, accidents or failure to abide by the instructions for use.





TECHNICAL DATA

Nebulizer:	EASY 2
Max filling volume:	8 ml
Min filling volume:	2 ml
Residual volume:	0.5 ml
Neb rate 1 min (NaCl 0,9%):	0.35 ml/min
Particle size:	4.07 μm - 61% < 5 μm

Air tube lenght:	1.5 m
Maximum pressure:	2.2 bar
Compressor air flow:	12 L/min
Operating air flow:	5 L/min
Acoustic noise level (Compressor without tube):	55 dBA
Operating cycle:	20 min ON / 40 min OFF
Operating conditions:	10-40 °C; 30-85% maximum relative humidity; 700-1060 hPa atmospheric pressure
Storage and shipping conditions:	-10 - +40 °C; 10-95% maximum relative humidity; 700-1060 hPa atmospheric pressure
Product Weight:	1,300 g
Dimensions:	140 x 137 x 92 mm
Power supply:	Power plug
Expected service life:	1,000 hours
IP Class:	IP21
Reference to standard:	EN13544-1; EN60601-1; EN60601-2; EN60601-1-6; IEC60601-1-1-11

We reserve the right to apply technical changes.





Air 100

F A M I L Y

System für Druckluft-Aerosoltherapie

DE

- | | | | |
|---|------------------------------|----|--|
| 1 | Kompressor | 9 | Zerstäuber EASY 2 |
| 2 | EIN/AUS-Taste | 10 | Weicher Nasenspender |
| 3 | Luftleitungseinlass | 11 | Luftschlauch |
| 4 | Halterung für den Zerstäuber | 12 | 5 Luftfilter |
| 5 | Länge des Netzkabels | 13 | Komponenten und Montage des Zerstäubers EASY 2 |
| 6 | Maske für Erwachsene | 14 | Austausch des Luftfilters |
| 7 | Maske für Kinder | | |
| 8 | Mundstück | | |



Bitte lesen Sie die Anleitung sorgfältig durch, bevor Sie dieses Gerät benutzen.



Anwendungsteil Typ BF.

Sehr geehrter Kunde,
dieses Gerät ist ein System zur Aerosoltherapie von hoher Qualität, ideal für den gelegentlichen häuslichen Einsatz.

Es ist ausgestattet mit dem Zerstäuber EASY 2 für die schnelle und wirksame Behandlung von Atemwegserkrankungen.

Es kann mit aller üblichen Arzneimitteln für die Aerosoltherapie eingesetzt werden. Bei Fragen, Problemen oder der Bestellung von Ersatzteilen wenden Sie sich bitte an Ihren Händler oder den COLPHARMA-Kundendienst. Alternativ können Sie auch die Website www.colpharma.com besuchen, die viele nützliche Informationen über unsere Produkte bietet.





VERWENDUNGSZWECK

Dieses Produkt ist für die Inhalation von Medikamenten zur Behandlung von Atemwegserkrankungen bestimmt.

Für wen dieses Gerät bestimmt ist

- Rechtlich qualifiziertes medizinisches Personal (Ärzte, Krankenpfleger und Therapeuten).
- Patienten in häusliche Pflege unter Anleitung von qualifiziertem medizinischem Personal.



Der Benutzer muss auch in der Lage sein, die Bedienung des Gerätes und den Inhalt der Betriebsanleitung allgemein zu verstehen.



Das Gerät darf nicht von Patienten benutzt werden, die nicht bei Bewusstsein sind oder nicht selbständig atmen.

Patienten, für die das Produkt bestimmt ist

Personen, die unter Atembeschwerden leiden und Inhalationsmedikamente einnehmen müssen.
Geeignet für Kinder und Erwachsene.

Umgebung

Dieses Produkt ist für den Einsatz zu Hause, in Krankenhäusern oder Arztpraxen bestimmt.

Vorgesehene Mindestlebensdauer

Die Mindestlebensdauer ist nachstehend angegeben und basiert auf der Annahme, dass das Produkt zweimal täglich, jeweils 7,5 Minuten lang, bei einer Umgebungstemperatur von 23 °C zum Sprühen von Salzlösung (2 ml) verwendet wird.

Die Lebensdauer kann je nach Umgebung, in der es eingesetzt wird, variieren.

- Kompressor (Hauptgerät): 3 Jahre.
- Zerstäuber - Luftschlauch - Mundstück - Nasenspender - Maske für Kinder - Maske für Erwachsene: 1 Jahr.

Die häufige Verwendung des Produkts kann seine vorgesehene Lebensdauer verkürzen.

- Luftfilter: 60 Tage.

Vorsichtsmaßnahmen für den Gebrauch

Die in der Betriebsanleitung angegebenen Warnhinweise und Vorsichtsmaßnahmen sind zu beachten.





WICHTIGE VORSICHTSMASSNAHMEN

- Befolgen Sie die Bedienungsanleitung. Dieses Handbuch enthält wichtige Informationen über den Betrieb und die Sicherheit dieses Gerätes. Bitte lesen Sie die Bedienungsanleitung vor der Inbetriebnahme des Gerätes sorgfältig durch und bewahren Sie sie zum späteren Gebrauch auf.
 - Dieses Gerät darf nur wie in dieser Anleitung beschrieben verwendet werden. Der Hersteller haftet nicht für Schäden, die durch unsachgemäßen Gebrauch entstehen.
 - Das Gerät ist nicht für die Anästhesie und Lungenbeatmung geeignet.
 - Das Gerät darf nur mit dem in der Bedienungsanleitung angegebenen Originalzubehör verwendet werden.
 - Verwenden Sie das Gerät nicht, wenn Sie denken, dass es beschädigt ist oder wenn Sie etwas Seltsames bemerken.
 - Öffnen Sie das Gerät niemals.
 - Dieses Gerät besteht aus empfindlichen Komponenten und muss mit Sorgfalt behandelt werden.
 - Beachten Sie die im Kapitel "Technische Daten" beschriebenen Lager- und Betriebsbedingungen!
 - Schützen Sie das Gerät vor:
 - Wasser und Feuchtigkeit
 - extremen Temperaturen
 - Stößen und Stürzen
 - Verunreinigungen und Staub
 - direktem Sonnenlicht
 - Hitze und Kälte
 - Verwenden Sie das Gerät nur mit von Ihrem Arzt verordneten Medikamenten und befolgen Sie die vorgeschriebene Dosierung, Dauer und Häufigkeit der Therapieanweisungen.
 - Kippen Sie den Zerstäuber nicht um mehr als 45°.
 - Verwenden Sie das Gerät nicht in der Nähe von starken elektromagnetischen Feldern wie Mobiltelefonen oder Funkanlagen. Halten Sie bei der Verwendung dieses Gerätes einen Mindestabstand von 3,3 m zu anderen Geräten ein.
 - Bewahren Sie das Gerät und sein Zubehör an einem sauberen Ort auf.
 - Verwenden und lagern Sie dieses Gerät nicht in Gegenwart von Rauch und Gas.
 - Verwenden Sie keine Medikamente, die im Zerstäuber verbleiben, sondern immer neue.
 - Nicht in Verbindung mit Anästhesie- oder Beatmungsvorrichtungen verwenden.
-  Achten Sie darauf, dass Kinder das Gerät nicht ohne Aufsicht von Erwachsenen benutzen. Einige Teile sind klein und könnten verschluckt werden. Achten Sie auf die Gefahr der Strangulierung bei Vorhandensein von Kabeln oder Schläuchen.



Elektronische Geräte müssen vorschriftsmäßig entsorgt werden und gehören nicht in den Hausmüll.





Die Verwendung dieses Gerätes ersetzt nicht die Rücksprache mit dem Arzt.

VORBEREITUNG UND VERWENDUNG DES GERÄTS

Bei der ersten Verwendung des Geräts wird empfohlen, es wie im Abschnitt "Reinigung und Desinfektion" beschrieben zu reinigen.

1. Öffnen Sie den Zerstäuber (9) und geben Sie die von Ihrem Arzt verschriebene Medikamentenmenge. Sicherstellen, dass Sie den Maximalwert nicht überschreiten (Abb. 2/A).
2. Wählen Sie das am besten geeignete Inhalationszubehör, wie von Ihrem Arzt verschrieben (Abb. 2/B).
3. Verbinden Sie den Zerstäuber mit dem Luftschlauch am Kompressor (Abb. 2/C), stecken Sie den Netzstecker in die Netzsteckdose ein und stellen Sie sicher, dass das Stromnetz den Angaben im vorliegenden Handbuch oder den Daten auf dem Typenschild des Gerätes entspricht.
4. Zum Einschalten des Gerätes die Taste EIN/AUS (2) drücken. Das Mundstück (8) in den Mund nehmen, den Nasenspender (10) unter die Nasenlöcher oder der Maske (6 oder 7) auf das Gesicht legen und sicherstellen, dass Mund und Nase abgedeckt werden.
5. Setzen Sie sich in einer entspannten Position mit geradem Oberkörper.
Legen Sie sich beim Inhalieren nicht hin.
6. Nachdem Sie den von Ihrem Arzt empfohlenen Inhalationszyklus beendet haben, drücken Sie die EIN/AUS-Taste (2), um das Gerät auszuschalten; ziehen Sie dann den Netzstecker heraus.
7. Stellen Sie sicher, dass sich kein Kondensat im Luftschlauch befindet. Im Falle von Kondensation schalten Sie das Gerät ein, um die Feuchtigkeit im Schlauch zu trocknen, und trennen Sie ihn dann wie oben beschrieben.
8. Entleeren Sie das restliche Medikament im Zerstäuber und reinigen Sie alle Komponenten wie in der Beschreibung im Abschnitt "Reinigung und Desinfektion".

 Dieses Gerät wurde für einen Betrieb 20 Min. ON / 40 Min. OFF konzipiert.

 Decken Sie das Gerät während der Verwendung nicht mit einem Tuch, Handtuch oder anderem Material ab, um Überhitzung oder Fehlfunktionen zu vermeiden.





REINIGUNG UND DESINFEKTION

Reinigen Sie alle Komponenten sorgfältig und entfernen Sie nach jeder Behandlung Arzneimittelrückstände und mögliche Verunreinigungen.

Der Kompressor (1) und der Luftschlauch (11) müssen mit einem sauberen, feuchten Tuch gereinigt werden.

 Reinigen Sie Ihre Hände immer gründlich, bevor Sie das Zubehör reinigen und desinfizieren.

 Waschen/Sterilisieren Sie alle Komponenten des Zerstäubers

 Setzen Sie den Kompressor weder Wasser noch Hitze aus.

 Ersetzen Sie den Luftschlauch beim Patientenwechsel oder bei Verunreinigungen.



Vor der Reinigung den Netzstecker aus der Netzsteckdose ziehen.



Der Kompressor ist nicht wasserdicht und darf nicht mit Flüssigkeiten in Berührung kommen. Bei Kontakt mit Flüssigkeiten ziehen Sie sofort den USB-Stecker, schalten Sie das Gerät aus und trocknen Sie es sorgfältig. Nicht in Flüssigkeiten eintauchen.

Reinigung mit Wasser

- Reinigen Sie alle Komponenten des Zerstäubers (**mit Ausnahme des Luftschlauches**) ca. 5 Minuten lang unter fließendem heißen Wasser und geben Sie bei Bedarf eine kleine Menge neutrales Reinigungsmittel hinzu, wobei Sie sich an die vom Reinigungsmittelhersteller festgelegten Dosierungen und Einschränkungen halten müssen.
- Spülen Sie alles gründlich ab, stellen Sie sicher, dass alle Rückstände entfernt und getrocknet sind.

Desinfektion

- Alle Komponenten (**außer dem Luftschlauch**) können mit chemischen Desinfektionsmitteln unter Verwendung der vom Desinfektionsmittelhersteller angegebenen Dosen und Einschränkungen desinfiziert werden.
- Die Desinfektionsmittel sind in der Regel in der Apotheke erhältlich.

Dampfsterilisation

- Alle Komponenten des Zerstäubers (**außer Luftschlauch und Masken**) können bei bis zu 100 °C (15-20 Min.) dampfsterilisiert werden.
- Lassen Sie die Komponenten nach der Sterilisation vor der weiteren Verwendung immer auf Raumtemperatur abkühlen.





 Den Sterilisationszyklus nicht wiederholen, solange die Komponenten noch heiß sind.

Sterilisation mit kochendem Wasser

- Alle Komponenten (**außer Luftschlauch und Masken**) können auch für max. eine Minute in kochendes Wasser getaucht werden.

 Kochen Sie die Komponenten in reichlich Wasser.

 Zerlegen Sie den Zerstäuber in alle seine Bestandteile und kochen Sie sie separat.

WARTUNG, LAGERUNG UND SERVICE

Bestellen Sie alle Ersatzteile bei Ihrem Händler und Ihrer Apotheke oder kontaktieren Sie den COLPHARMA-Kundendienst (siehe Einführung).

- Überprüfen Sie immer, ob der Filter ständig sauber ist und tauschen Sie ihn bei Verschmutzung sofort oder nach maximal 60 Tagen Gebrauch aus. Ersatzfilter werden mit dem Gerät mitgeliefert.
- Zum Auswechseln des Filters (14) die Filterabdeckung aus ihrem Sitz entfernen.
- Den gebrauchten Luftfilter entfernen und den neuen Filter einsetzen. Setzen Sie den Filterhalter wieder in sein Gehäuse ein.
- Verwenden Sie das Gerät nicht ohne Filter. Verwenden Sie nur Originalfilter.
- Versuchen Sie nicht, den Filter zu waschen. Wenn der Filter nass ist, ersetzen Sie ihn. Ein nasser Filter kann dazu führen, dass das Gerät blockiert wird.
- Waschen Sie den Filterhalter regelmäßig (nicht kochen) und trocknen Sie ihn sorgfältig, bevor Sie ihn wieder in den Sitz einsetzen.

 Öffnen Sie niemals den Kompressorraum.

- Reparaturen dürfen nur von qualifiziertem Personal durchgeführt werden.





STÖRUNGEN UND BEHEBUNG

Das Gerät schaltet sich nicht ein

- Sicherstellen, dass der Netzstecker sicher in die Netzsteckdose eingesteckt ist.
- Vergewissern Sie sich, dass die EIN/AUS-Taste (2) gedrückt wurde.
- Sicherstellen, dass das Gerät innerhalb der im vorliegenden Anweisungshandbuch angegebenen Betriebsgrenzwerte arbeitet (20 Min. ON / 40 Min. OFF).

Die Zerstäubung ist schwach oder nicht vorhanden

- Vergewissern Sie sich, dass der Luftschlauch (11) an beiden Enden richtig angeschlossen ist.
- Vergewissern Sie sich, dass der Luftschlauch nicht gequetscht, gebogen, verschmutzt oder verstopft ist. Ersetzen Sie ihn bei Bedarf durch einen neuen.
- Vergewissern Sie sich, dass der Zerstäuber vollständig zusammengebaut ist (13) und dass seine Komponenten korrekt montiert sind.
- Vergewissern Sie sich, dass das Medikament in den Zerstäuber gegeben wurde.
- Vergewissern Sie sich, dass der Filterkörper sauber ist und der Filterhalter richtig positioniert ist.

Das Gerät ist lauter

- Vergewissern Sie sich, dass der Filter richtig in seinem Sitz (14) eingesetzt ist.



Versuchen Sie nicht, das Gerät zu reparieren, wenden Sie sich an den COLPHARMA-Kundendienst.

GARANTIE

Auf dieses Gerät wird eine Garantie von **3 Jahren** ab Kaufdatum gewährt. Die Garantie gilt nur gegen Vorlage der Quittung.

- Die Garantie umfasst nur den Kompressor.
- Die Ersatzteile wie Zerstäuber, Masken, Mundstück, Nasenspender und Luftschlauch haben eine Garantie von einem Jahr auf Fabrikationsfehler, nicht jedoch auf Abnutzung durch normalen Verschleiß.
- Das Öffnen oder Manipulieren des Gerätes führt zum Erlöschen der Garantie.
- Die Garantie erstreckt sich nicht auf Schäden, die durch unsachgemäße Handhabung, Unfälle oder Nichtbeachtung der Betriebsanleitung entstehen.





TECHNISCHE SPEZIFIKATIONEN

Zerstäuber:	EASY 2
Maximales Füllvolumen:	8 ml
Minimales Füllvolumen:	2 ml
Restvolumen:	0,5 ml
Zerstäubungsgeschwindigkeit (NaCl 0,9%):	0,35 ml/Min.
Partikelgröße:	4,07 µm - 61% < 5 µm
<hr/>	
Länge des Luftschlauchs:	1,5 m
Maximaler Druck:	2,2 bar
Strömung zum Kompressor:	12 L/min
Betriebsströmung:	5 L/min
Schallpegel (ohne Schlauch):	55 dBA
Betriebszyklus:	20 min ON / 40 min OFF
Betriebsbedingungen:	10 - 40 °C; 30 - 85 % max. relative Feuchtigkeit; 700 - 1.060 hPa atmosphärischer Druck
Versand- und Lagerbedingungen:	- 10 - + 40 °C; 10 - 95 % max. relative Feuchtigkeit; 700 - 1.060 hPa atmosphärischer Druck
Produktgewicht:	1.300 g
Abmessungen:	140 x 137 x 92 mm
Stromversorgung:	Netzstecker
Nutzungsdauer:	1.000 Stunden
IP-Klasse:	IP21
Referenz-Standard:	EN13544-1; EN60601-1; EN60601-2; EN60601-1-6; IEC60601-1-1-11

Technische Änderungen vorbehalten.





Air 100

F A M I L Y

FR

Système pour aérosolthérapie à air comprimé

- | | | | |
|---|----------------------------|----|---|
| 1 | Compresseur | 9 | Nébuliseur EASY 2 |
| 2 | Bouton ON/OFF | 10 | Embout nasal souple |
| 3 | Prise tube à air | 11 | Tube à air |
| 4 | Support pour le nébuliseur | 12 | 5 Filtres à air |
| 5 | Cordon d'alimentation | 13 | Composants et assemblage du nébuliseur EASY 2 |
| 6 | Masque adultes | 14 | Remplacement du filtre à air |
| 7 | Masque pédiatrique | | |
| 8 | Embout buccal | | |



Lire attentivement les instructions avant d'utiliser l'appareil.



Partie appliquée de type BF.

Cher client,

Ce dispositif est un système de haute qualité pour aérosolthérapie, idéal pour un usage occasionnel à domicile.

Il est équipé du nébuliseur EASY 2 conçu pour le traitement rapide et efficace des affections respiratoires. Il peut être utilisé avec tous les médicaments habituellement prescrits pour l'aérosolthérapie. Pour toute question, problème ou commande de pièces de rechange, contacter votre revendeur ou le service client COLPHARMA. Une documentation est également disponible sur le site www.colpharma.com qui fournit de nombreuses informations sur l'ensemble de nos produits.





USAGE PRÉVU

Ce produit est destiné à l'inhalation de médicaments prescrits pour le traitement des troubles respiratoires.

Utilisateurs visés

- Personnel médical légalement autorisé (médecins, infirmières et thérapeutes).
- Patients bénéficiant d'une assistance médicale à domicile pour le traitement, sous la surveillance d'un personnel qualifié.



L'utilisateur doit être en mesure de comprendre le fonctionnement général de l'appareil ainsi que le contenu du manuel d'instructions.



L'appareil ne doit pas être utilisé par des patients non conscients ou ne respirant pas spontanément.

Patients visés

Personnes souffrant de problèmes respiratoires et soumis à une prise de médicaments par inhalation. Indiqué pour patients en âge pédiatrique et adultes.

Environnement

Ce produit est destiné à un usage à domicile ou dans des établissements de soins (hôpital, ambulatoire).

Durée minimale prévue

Les périodes de durée minimale sont indiquées ci-dessous et se basent sur une utilisation du produit par nébulisation d'une solution saline (2 ml) lors de 2 séances quotidiennes de 7 minutes 30 à une température ambiante de 23°C.

La durée de la séance peut varier en fonction de l'environnement d'utilisation.

- Compresseur (unité principale) : 3 ans.
- Nébuliseur - Tube à air - Embout buccal - Embout nasal - Masque pédiatrique - Masque adultes : 1 an.
Un usage fréquent du produit pourrait réduire la durée de vie prévue.
- Filtre à air : 60 jours.

Précautions d'emploi

Respecter les avertissements et les mesures de précautions fournis dans le manuel d'instructions.





IMPORTANTES MESURES DE PRÉCAUTION

- Suivre les instructions d'utilisation. Ce manuel contient des informations importantes relatives au fonctionnement et à la sécurité de l'appareil. Lire attentivement le manuel d'instructions avant d'utiliser l'appareil et le conserver pour pouvoir le consulter ultérieurement.
 - Utiliser cet appareil exclusivement tel que décrit dans ce manuel. Le fabricant ne peut être tenu responsable des dommages résultants d'une mauvaise utilisation de l'appareil.
 - L'appareil n'est pas adapté à l'anesthésie ni à la ventilation pulmonaire.
 - L'appareil doit être utilisé uniquement avec les accessoires d'origine figurants dans le manuel d'instructions.
 - Ne pas utiliser l'appareil si vous estimez qu'il est endommagé ou si vous constatez une anomalie.
 - Ne jamais ouvrir l'appareil.
 - Les composants de cet appareil sont fragiles et doivent être manipulés avec précaution.
 - Respecter les conditions de stockage et de fonctionnement décrites à la section "Spécifications techniques".
 - Protéger l'appareil contre :
 - eau et humidité
 - températures extrêmes
 - chocs et chutes
 - contamination et poussière
 - lumière directe du soleil
 - chaleur et froid
 - Utiliser l'appareil uniquement avec les médicaments prescrits par votre médecin, en respectant les indications concernant le dosage, la durée et la fréquence du traitement.
 - Ne pas incliner le nébuliseur au-delà de 45°.
 - Ne pas utiliser l'appareil à proximité de puissants champs électromagnétiques tels que téléphones portables ou installations radio. Maintenir une distance minimale de 3,3 m par rapport aux autres dispositifs quand l'appareil est en cours de fonctionnement.
 - Ranger l'appareil et ses accessoires dans un endroit propre.
 - Ne pas utiliser et ne pas stocker cet appareil dans un endroit où il pourrait être exposé à des fumées ou à des gaz.
 - Ne pas utiliser les résidus de médicaments présents dans le nébuliseur, verser une nouvelle dose pour chaque séance.
 - Ne pas utiliser dans le cadre d'anesthésie ou de ventilation respiratoire.
-  S'assurer que les enfants utilisent l'appareil sous la surveillance d'un adulte. Certaines parties sont de petite taille et pourraient être ingérées. Faire attention au risque d'étranglement en présence de câbles ou de tuyaux.





L'appareil doit être éliminé conformément aux directives locales sur la mise au rebut des appareils électriques.



L'utilisation de cet appareil ne remplace pas la consultation d'un médecin.

PRÉPARATION ET UTILISATION DU DISPOSITIF

Avant la première utilisation, il est recommandé de nettoyer l'appareil en suivant les instructions fournies à la section « Nettoyage et désinfection ».

1. Ouvrir le nébuliseur (9) et verser la dose de médicament selon les prescriptions de votre médecin. Veiller à ne pas dépasser le niveau maximum (Fig. 2/A).
2. Choisir l'accessoire le plus approprié à l'inhalation en suivant les prescriptions de votre médecin (Fig. 2/B).
3. Raccorder le nébuliseur avec le tube à air au compresseur (Fig. 2/C) et brancher la fiche du cordon d'alimentation au secteur en vous assurant préalablement que le voltage est conforme aux spécifications indiquées dans ce manuel ou sur la plaque signalétique de l'appareil.
4. Appuyer sur le bouton ON/OFF (2) pour allumer l'appareil. Introduire l'embout buccal (8) dans votre bouche, placez l'embout nasal (10) sous vos narines ou fixez le masque facial (6 ou 7) en vous assurant qu'il couvre la bouche et le nez.
5. S'asseoir dans une position détendue, en maintenant le buste droit.
Ne pas s'allonger pendant l'inhalation.
6. Une fois la séance d'inhalation terminée selon les prescriptions du médecin, éteindre l'appareil en appuyant sur le bouton ON/OFF (2) et débrancher la prise du secteur.
7. Vérifier l'absence de condensation dans le tube à air. En cas de condensation, allumer l'appareil pour éliminer l'humidité présente dans le tube, puis le débrancher tel qu'indiqué ci-dessus.
8. Éliminer le résidu du médicament présent dans le nébuliseur et nettoyer l'appareil tel que décrit à la section « Nettoyage et désinfection ».



Cet appareil a été conçu pour un fonctionnement 20 min. ON / 40 min. OFF.



Ne pas couvrir l'appareil en cours de fonctionnement avec un chiffon, une serviette ou autre pour éviter les risques de surchauffe ou de dysfonctionnement.





NETTOYAGE ET DÉSINFECTION

Nettoyer soigneusement tous les composants et éliminer les résidus de médicaments et les éventuelles impuretés après chaque traitement.

Le compresseur (1) et le tube à air (11) doivent être nettoyés avec un chiffon propre et humide.

 Toujours bien se laver les mains avant de procéder au nettoyage et à la désinfection des accessoires.

 Laver/stériliser tous les composants du nébuliseur.

 Ne pas exposer le compresseur à l'eau ou à la chaleur.

 Remplacer le tube à air à chaque nouvel utilisateur ou en cas de présence d'impuretés.



Avant le nettoyage, débrancher la fiche secteur de la prise de courant.



Le compresseur n'est pas étanche et ne doit pas entrer en contact avec des liquides. En cas de contact avec des liquides, débrancher immédiatement la prise du secteur, éteindre l'appareil et le sécher soigneusement. Ne pas l'immerger.

Nettoyage à l'eau

- Nettoyer tous les composants (**à l'exception du tube à air**) sous l'eau chaude du robinet pendant environ 5 minutes en ajoutant au besoin un peu de détergent neutre, en respectant le dosage et les limitations prévus par le fabricant du détergent.
- Rincer abondamment en s'assurant que tous les résidus sont éliminés, puis laisser sécher.

Désinfection

- Tous les composants (**à l'exception du tube à air**) peuvent être désinfectés avec des désinfectants chimiques en utilisant les doses et les limites prévues par le fabricant du désinfectant.
- Les désinfectants sont généralement vendus en pharmacie.

Stérilisation à la vapeur

- Tous les composants (**à l'exception du tube à air et des masques**) peuvent être stérilisés à la vapeur jusqu'à 100°C (15-20 min.).
- Après la stérilisation, toujours laisser les composants refroidir à température ambiante avant de les réutiliser.

 Ne pas répéter le cycle de stérilisation tant que les composants sont chauds.





Stérilisation à l'eau bouillante

- Tous les composants (à l'**exception du tube à air et des masques**) peuvent être plongés également dans l'eau bouillante pendant 1 minute maximum.

 Faire bouillir les composants dans une grande quantité d'eau.

 Démonter tous les composants du nébuliseur et les faire bouillir séparément.

ENTRETIEN, CONSERVATION ET SERVICE

Commander toutes les pièces de rechange auprès de votre revendeur ou pharmacie ou contacter le service client COLPHARMA (voir Avant-propos).

- Il est recommandé de remplacer le nébuliseur, l'embout buccal, l'embout nasal et les masques après 1 an d'utilisation.
- Ne pas sécher le nébuliseur au four ni à l'aide d'un sèche-cheveux car ses composants pourraient se détériorer.
- Toujours vérifier la propreté du filtre et le remplacer immédiatement s'il est encrassé ou après 60 jours d'utilisation maximum. Des filtres de rechange sont fournis avec l'appareil.
- Pour remplacer le filtre (14), extraire le couvre-filtre de son compartiment. Extraire le filtre à air usagé et insérer le nouveau filtre. Repositionner le couvre-filtre dans son compartiment.
- Ne pas utiliser l'appareil sans filtre. Utiliser exclusivement les filtres d'origine.
- Ne pas tenter de laver le filtre. Si le filtre est mouillé, le remplacer. Un filtre humide peut entraîner le blocage de l'appareil.
- Laver régulièrement le couvre-filtre (ne pas le faire bouillir) en le séchant soigneusement avant de le repositionner dans son compartiment.

 Ne jamais ouvrir le compartiment compresseur.

- D'éventuelles réparations doivent être effectuées exclusivement par un réparateur agréé.





DYSFONCTIONNEMENTS ET RÉOLUTION DES PROBLÈMES

L'appareil ne s'allume pas

- Vérifier que la fiche secteur est bien insérée dans la prise de courant.
- Vérifier que l'appareil est en position ON (2).
- S'assurer que l'appareil fonctionne dans les limites indiquées dans ce manuel d'instructions (20 min. ON / 40 min. OFF).

Nébulisation faible ou nulle

- S'assurer que le tube à air (11) est correctement raccordé aux deux extrémités.
- Contrôler que le tube à air n'est pas écrasé, plié, sale ou obstrué. Au besoin, le remplacer par un tube neuf.
- Vérifier que le nébuliseur est parfaitement assemblé (13) et que chaque composant est monté correctement.
- Vérifier que le médicament a été versé dans le nébuliseur.
- Contrôler la propreté du filtre et la correction position du couvre-filtre.

L'appareil est anormalement bruyant

- S'assurer que le filtre est correctement inséré dans son compartiment (14).



Ne pas tenter de réparer l'appareil, contacter le service client COLPHARMA.

GARANTIE

Ce dispositif est couvert par une garantie de **3 ans** à compter de la date d'achat. La garantie est valable uniquement sur présentation du justificatif d'achat.

- La garantie couvre exclusivement le compresseur.
- Les pièces consommables tels que nébuliseur, masques, embout buccal et tube à air sont garantis 1 an contre tout défaut de fabrication, la garantie ne couvre pas la détérioration due à l'usure naturelle des pièces.
- L'ouverture ou la modification de l'appareil annule la garantie.
- La garantie ne s'applique pas aux dommages résultants d'une mauvaise utilisation, négligence ou non-respect des instructions fournies dans ce manuel.





DONNÉES TECHNIQUES

Nébuliseur :	EASY 2
Volume max. du réservoir :	8 ml
Volume min. du réservoir :	2 ml
Volume résiduel :	0,5 ml
Vitesse de nébulisation (NaCl 0,9%) :	0,35 ml/min.
Taille des particules :	4,07 µm - 61% < 5 µm
<hr/>	
Longueur tube à air :	1,5 m
Pression maximale :	2,2 bars
Débit du compresseur :	12 L/min.
Débit d'aérosol :	5 L/min.
Niveau sonore (sans tube) :	55 dBA
Modes de fonctionnement :	20 min. ON / 40 min. OFF
Conditions de fonctionnement :	10-40°C ; 30-85% humidité relative maximale ; 700-1060 hPa pression atmosphérique
Conditions de livraison et stockage :	-10 - +40°C ; 10-95% humidité relative maximale ; 700-1060 hPa pression atmosphérique
Poids produit :	1 300 g
Dimensions :	140 x 137 x 92 mm
Alimentation :	Fiche secteur
Durée de conservation :	1 000 heures
Indice de protection (IP) :	IP21
Normes :	EN13544-1 ; EN60601-1 ; EN60601-2 ; EN60601-1-6 ; IEC60601-1-1-11

COLPHARMA se réserve le droit d'apporter des modifications techniques.





Symbol	IT	EN	DE	FR
	Descrizione	Description	Beschreibung	Description
	Lotto	Lot number	Lot Symbol	N°de lot
	Numero di riferimento	Ref number	Referenznummer	N°reference
	Conforme al regolamento europeo	Compliant with European regulation	Entspricht der Europäischen Verordnung	Conforme à la réglementation européenne
	Dispositivo medico	Medical device	Medizinisches Gerät	Dispositifs medical
	Produttore	Manufacturer	Hersteller	Fabricant
	Importato e distribuito da	Imported and distributed by	Importiert und vertrieben von	Importé et distributé par
	Numero di serie	Serial number	Seriennummer	N° de serie/
	Rappresentante europeo	European representative	Europäischer Repräsentant	Représentant européen



Distributore per l'Italia

COLPHARMA

Colpharma s.r.l.
Parma - Italy

www.colpharma.com



HONSUN (NANTONG) Co., Ltd
No.8 Tongxing Road Nantong Economic & Technological Development area, 226009, Jiangsu Province, P. R. China



Shanghai International Holding Corp. GmbH (Europe)
Eiffelstrasse 80, 20537 Hamburg, Germany

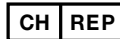

MedNet SWISS GmbH,
D4 Platz 4, 6039 Root D4, Switzerland

Manuale Air 100 FAMILY - cod.12475 - Giu. 2024

